



OMV

OFFICINE
METALMECCANICHE
VIBONESI

COMPANY
PROFILE

2023

EMPOWERING **YOUR SUCCESS** DAILY

Why **Choose Us**

The company started its operations in 1973 and nowadays this organization **boasts for more than 50 years of experience** in design, manufacturing and supply of products

for Oil & Gas, Petrochemical, Energy, Gas Processing fields and Pharmaceutical.

From May 2023, Officine Metalmeccaniche Vibonesi S.r.l. **OMV** has acquired the full control of CMC S.r.l.

Corporate Responsibility

Accountability



Performance









Team Work





Index

Content

-  About **Our Company** P. **4**
-  Company **Certification** P. **6**
-  Service **Engineering** P. **8**
-  Products and **Service** P. **16**
-  Transportation and **Logistics** P. **22**
-  Reference **List** P. **24**

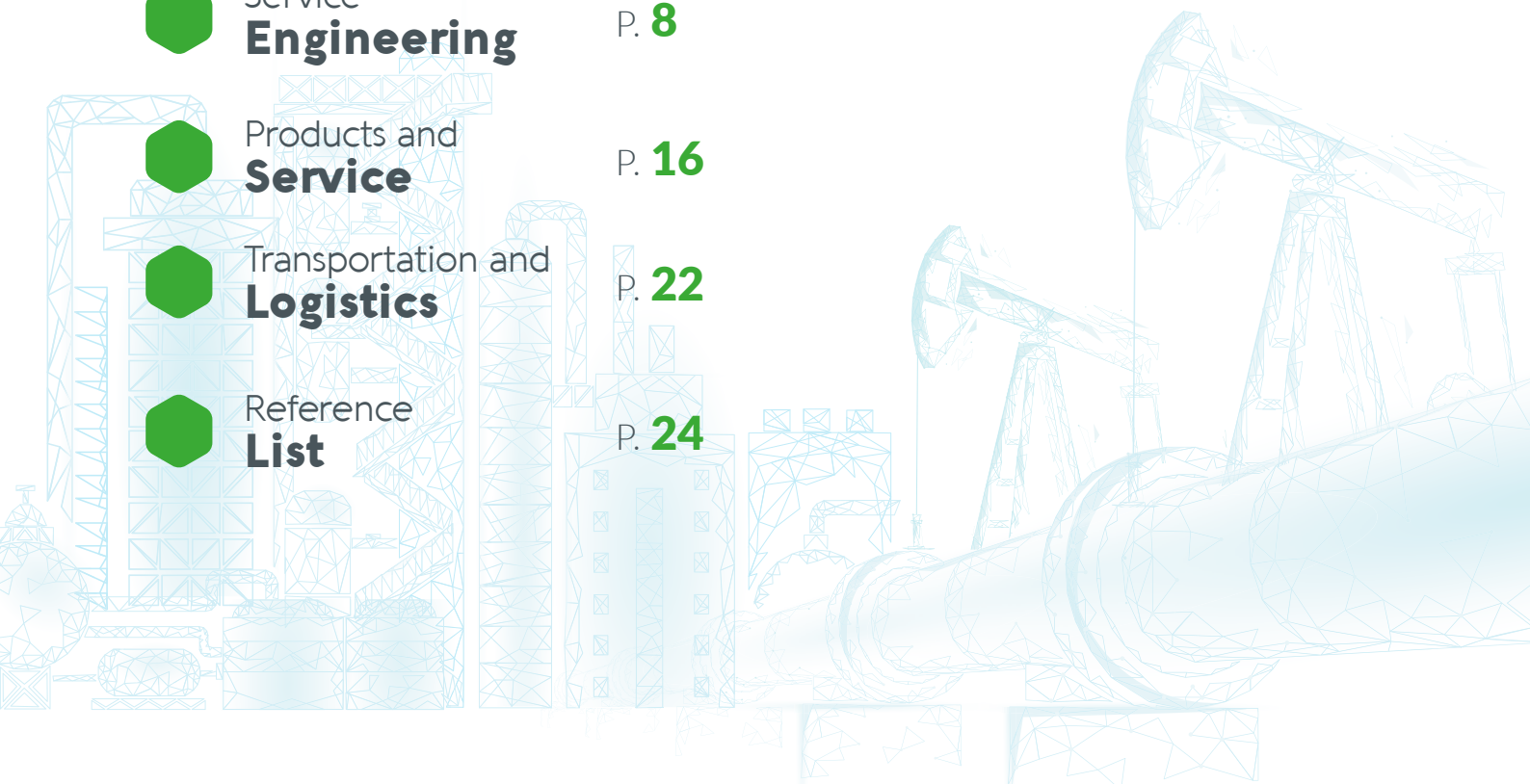



About Our Company

In our production facility, with the best in class production technologies, we realize different types of heaters for refineries, air coolers heat exchangers, shell and tube heat exchangers, pressure vessels, waste heat recovery units, prefabrication of coils

and piping, pig tails, skids prefabrication and assembly, electric and instrumental component installations, tanks, stacks, ducts, thermal incinerators, transfer lines, derricks and heavy structural work.

Our production capacity is roughly 200.000 hours/year and about 400 tons/month of

structural work carbon and stainless steel.



40 Thousand sqm
uncovered
10 Thousand sqm
covered



135 Human
Resource



400 Tons
Month



200 Thousand
Hours Year

The Industrial Zone of Porto Salvo in Vibo Valentia is located at 2 km from **Vibo Valentia Port**.

International Airport of Lamezia Terme and Gioia Tauro Port are both 30 minutes away.



Vibo Valentia
Port



Lamezia
International Airport



Gioia Tauro
Port



About Our Team

With the Customer always at the center of our activities and Customer satisfaction as goal, our Management and the entire

team are capable to understand Customer expectation and deliver an excellent level of service in terms of Quality, Time and Cost.



Domenico G. Arena
President and Managing Director



Giuseppe Germinario
General Manager



EHS Manager



Luigi Dusci
Sales Manager



Gaetano Artusa
Operation Manager



Vincenzo Donato
Quality Manager



Bruna Rachiele
Engineering Manager



Tania Mobilio
Administration Manager



Maria R. Cirianni
Supply Chain Manager



Company Certification

Our Quality System is certified to the internationally **recognized standards ISO 9001**, and the entire Company operates

according to the most modern concepts codified in our Quality manual and procedures.



EN ISO 9001:2015



EN 1090-1:2009+A1:2001



ISO 3834-2:2005



The following ASME certifications: U2, U, S, National Board and FITOK IT 18-010 HT are being obtained and will be added as soon as issued.

We have launched a voluntary ISO 14001 and ISO 45001 certification project, to adopt the

best environmental management and occupational health and safety management practices.



Service
Engineering



Engineering
Thermodynamics



Engineering
Mechanics



Engineering
Design

Engineering & Design

Our team of engineers and technicians is capable to design equipment as per specific customer requirements and international codes and standards.

We support the customer in the engineering of the industrial product starting from calculation with the aid of specific software solutions such as PVElite®, Passat®, IDEA StatiCa® and so on, up to final design and construction drawings, with the latest 3D software such as Tekla Structures®, Advance Steel® and AutoCad®.

Our production engineers support the industrialization of production processes,

guaranteeing quality through standard production and assembly procedures, making the processes sustainable.

Our team can manage industrial projects, from the feasibility study of the product to the CAD design of the components up to realization, starting from basic process data or data sheet.

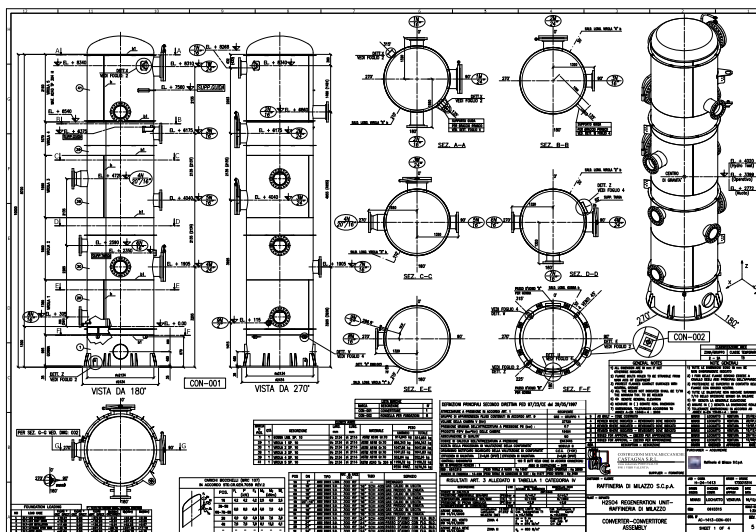

Engineering Design **Air Coolers**

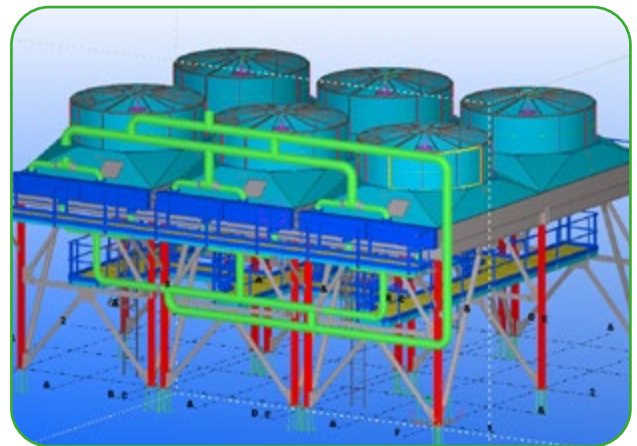

Project: Garraf 3 Oil Trains - No.3 Air Cooler Heat Exchanger
Client: Progetti Europa & Global Spa
Site: Iraq

Engineering Design Vessels

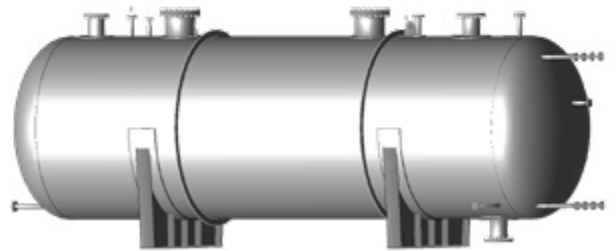
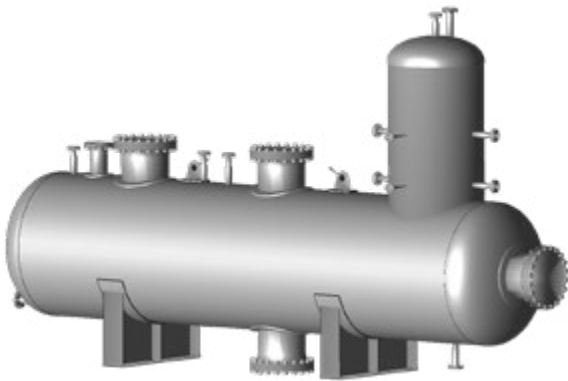

Project: Lukoil Vessel (Example of Vessels: Absorber Inlet Separator 83-V-0306 / Lean Accumulation Drum 34-V-2104)
Client: Kt Kinetics Technology
Site: Kstovo Refinery, Russia

Engineering Design Heaters

- Coils Prefabrication
- Radiant Modularization
- Convection Modularization
- Stack

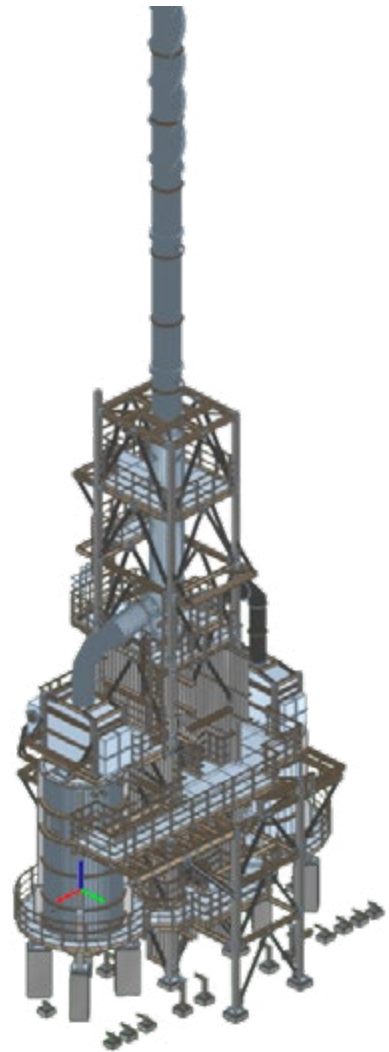

Project: Various
Client: Various
Site: Various

Engineering Design Incinerators



- Combustion Chamber
- Incinerator Stack
- Supporting Structure

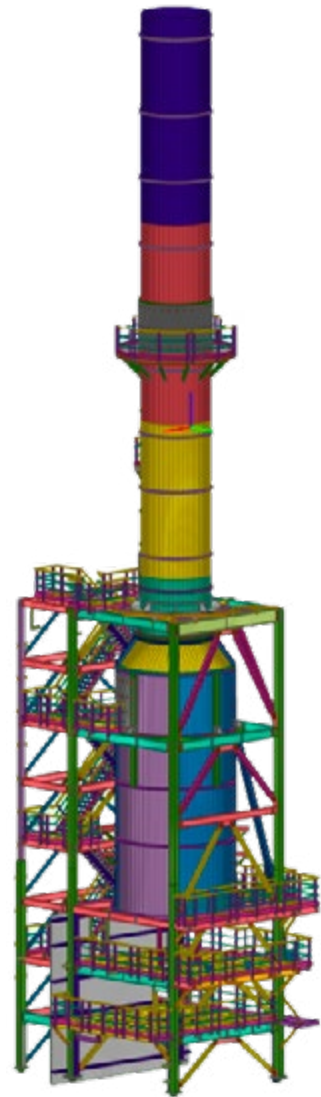

Project: Nizhnekamsk Incinerator (Steel Structure, Combustion Chamber and Stack for Incinerator)
Client: Selas Linde GmbH
Site: Nizhnekamsk, Republic of Tatarstan, Russian Federation

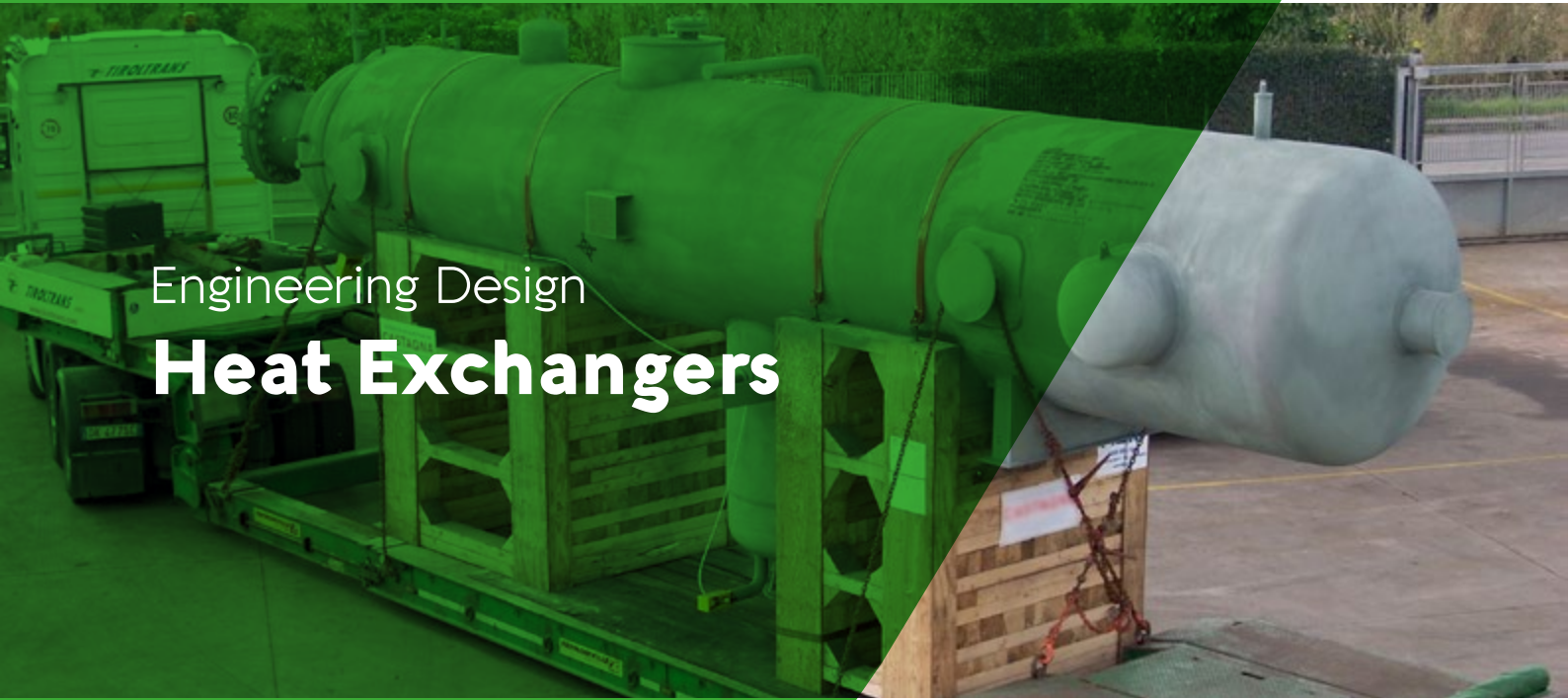

Engineering Design Heat Exchangers

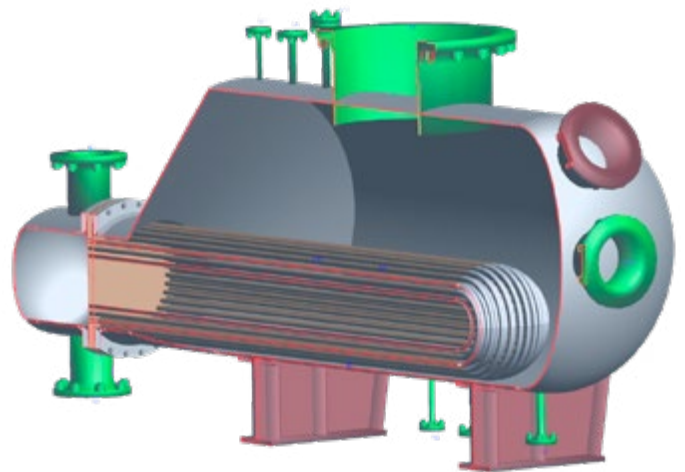

Project: Various
Client: Various
Site: Various

Engineering Design Stacks

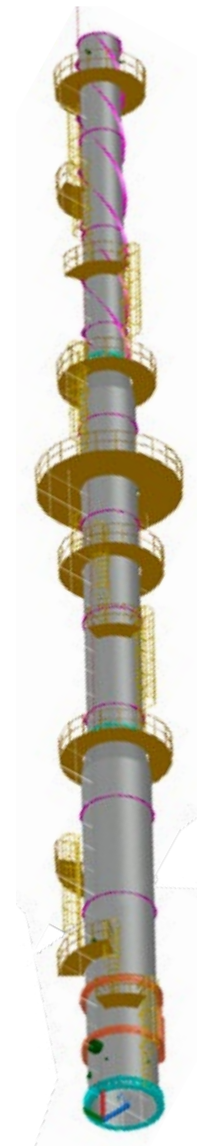

Project: Incinerator Stack
Client: Siirtec Nigi Spa
Site: Assiut Refinery, in Assiut, Manfalut, Gahdam, Middle of Egypt



Product and **Service**

 **Procurement**

 **Fabrication**

 **Testing and Treatments**

Heaters | Furnaces

- Cylindrical heaters with top convection and stack.
Coil material CS / SS / LA / Duplex / Ni Alloy with straight or spiral tubes - up to diameter >8m; length >25m; weight >200T.
- BOX heaters with top convection and stack.
Coil material CS / SS / LA / Duplex / Ni Alloy with straight or hairpin tubes - up to width/height >7m; length >25m; weight >200T.



Vessels

- Atmospheric vessels material CS / SS / LA / Duplex / Ni Alloy up to diameter >8m; length >25m; weight >200T.
- Pressure vessels material CS / SS / LA / Duplex / Ni Alloy up to diameter >8m; length >25m; weight >200T.
- Steam drums material CS / SS / LA / Duplex / Ni Alloy up to diameter >8m; length >25m; weight >200T.



Waste Heat Recovery Unit

Coil material CS / SS / LA / Duplex / Ni Alloy - up to width/height >7m; length >25m; weight >200T.



Products and Services



Skids

Piping prefabrication material CS / SS / LA / Duplex / Ni Alloy.

Equipment and piping supporting skid base.

Electrical and instruments installation.

FAT Test and final preparation for shipment.



Heat Exchangers

- Shell and tube heat exchangers - material CS / SS / LA / Duplex / Ni Alloy up to diameter >4m; length >16m; weight >200T.
- Air coolers - material CS / SS / LA / Duplex / Ni Alloy.
- Headers for air coolers (Plug, Bonnet, Cover plate type) material CS / SS / LA / Duplex / Ni Alloy.
- Automatic or manual recirculation systems.

Vaporizers for LNG

- SCV type (Submerged combustion vaporizers)
- ORV type (Open Rack Vaporizer)



Steel Stacks Ducting

- Steel stacks in CS / SS up to diameter >7m; length >25m; weight >200T for each module.
- Accessories (Damper, Venturi expansion joints, etc...)
- Air and FG ducting.



Tanks (API 650 / 620 etc)

- Tanks, shop fabricated CS up to diameter >8m; length >25m; weight >200T.
- Tanks, field assembled in CS / SS / LA - All diameters.

Columns | Flares

- Columns without internals
- Columns with internals
- Flare stacks

Reactors

- Reactors
- Thermal Reactors

Other Exchangers

- Convection banks.
- Boilers
- Steam generators
- Steam condensers
- Desuperheaters / Quench fittings
- Air heaters/coolers (granulation)
- Double pipe heat exchangers

*Material CS / SS / LA / Duplex / Ni Alloy - up to width/height >7m; length >25m; weight >200T.



Machinery and Equipment

We have best-in-class Machinery and Equipment as the Automatic CNC single spindle drilling lines for sections equipped with a 6 positions automatic tool changer and a non-contact laser.

A Finning department is equipped with an High Frequency Finning Machine able to produce solid and serrated finning tubes with a diameter from 1" to 8" and up to 22 mt. in length and a Finning machine

for applied fins (g-fins, l-footed, etc.). An investment project is in progress to expand the production capacity for applied and an extruded machines.





Equipment	Capacity/Model
Gantry Type Milling and Drilling Workstation	1200 X 4000 Mm
Gantry Type Milling and Drilling Workstation	1200 X 4000 Mm
3 Axes Manual Milling Machine	1200 X 4000 Mm
Milling And Drilling Workstation With Mobile Bench	1200 X 4000 Mm
Automatic Cnc Single Spindle Drilling Line	15000 Mm
Heater For Post Weld Heat Treatments (20 Burners 160 Kw Each)	6000 X 6000 X 18000 Mm
Heater For Post Weld Heat Treatments	1000 Kw
Burner For Dryout	1700 Kw
Plasma Cutting Xpr 260 Xd	14000 X 2500 X 40 Mm
Plasma Cutting Ht2000	12000 X 2500 X 40 Mm
Bending Machine	Futura 400/70 - 14500 X 12 - 1200 Ton
Rolling Machine	3000 X 40 - 2000 X 8 Mm
Cutting Machine	Maxima 60/10 - 6000 X 15 - 3200 X 5
Tube And Profiles Bending Machine	Ar 110/180 - 4" /10"Max
Tube And Profiles Bending Machine	Ar 110 - 4" Max
3 Axis Cnc Tube Bending Machine	3" Max - Raggio 50 Min.
Submerged Arc Welding Machine With Guides And Harm	1000 Ah
Submerged Arc Welding Machine Double Head	2 X 1000 Ah
Submerged Arc Welding Machine For Internals	Braccio Lg > 3000
High Frequency Finning Machine	Min 1" Max 8" Lg 22000
Equipment For Local Pwht By Resistance	Da 6 A 24 Canali
Cranes	140, 40, 20 And 12 Ton
Bridge Cranes	4x10 Ton + 2x16 Ton + 2x32 Ton
Refractory Anchors Machine	
Sandblasting Boot	7000 X 7000 X 16000
Rolling Machines	Cs-1000



Transportation and **Logistics**

We can manage FOB and/or any kind of delivery to different destinations thanks to our skilled logistics team and the strategic logistics position.



Smart Delivery

The geographical position of our company is strategic and functional. In fact, we are just a few minutes away from the most important European goods sorting hubs.



Port of Vibo Valentia

The port of Vibo Marina is affected by commercial flows strictly connected to the productive activities and industrial settlements present in the territory of the Vibo Marina province. It specializes in the distribution of petroleum.



International Airport of Lamezia Terme

Lamezia Terme International Airport (IATA: SUF; ICAO: LICA), also known as Sant'Eufemia Airport, is the main international airport serving Lamezia Terme in Calabria (Italy).



Port of Gioia Tauro

Located in the heart of the Mediterranean, Gioia Tauro is the largest transshipment terminal in Italy and one of the most important traffic hubs container in the Mediterranean basin. It has 5130 meters of docks and the port yards have a total area of approximately 1 million and 800 thousand square meters

The port of Vibo Valentia Marina is located in the southern part of the Gulf of S. Eufemia, it is protected to the west by an elbow breakwater and to the east by a two-arm breakwater pier completely quayed (Generale Malta quay and Molo Cortese). Inside the port basin there are various docks (Fiume, Tripoli, Bengasi, Papandrea and Buccarelli) intended for both commercial, military and recreational operations. From the root of the "Generale Malta" quay towards the "Fiume" quay there are various floating piers intended for pleasure boats.

Incoming commercial traffic is mainly made up of fuels and gas destined for coastal depots and factories in the Vibo Marina area, while outgoing traffic is essentially represented by industrial products from the neighboring industrial area.

In addition to commercial activities, within the port there is a significant movement of pleasure boats that use essential services, such as reception and refueling. This movement in the summer period reaches high levels of attendance and represents an important aspect for the provincial tourism sector.



Reference List

CLIENT:	CUSTOMER:	LOCATION:	ITEM DESCRIPTION:	YEAR
ALFALAVAL OLMI S.p.A.	ENI	GELA-ENI	STEELWORK (JOB 11541) - RUNNING TEST	2023
C.P.S. S.r.l.	C.P.S. S.r.l.	PALMI	REPAIR OF HYDROELECTRIC TURBINE	2023
ALFALAVAL OLMI S.p.A.	REPSOL	CARTAGENA - SPAIN	TRANSPORT BEAMS	2022
ALFALAVAL OLMI S.p.A.	NCOC	KAZAKHSTAN	STEELWORK - BUNDLE FRAME - STEAM COIL	2022
ALFALAVAL OLMI S.p.A.	WOOD GROUP NORWAY AS	KMU EPCI PROJECT	SHIM PLATE AND LOCKING DEVICES	2022
ALFALAVAL OLMI S.p.A.	VPR ENERGY BV	NETHERLAND	DESIGN AND 3D MODELING	2022
ALFALAVAL OLMI S.p.A.	VPR ENERGY BV	NETHERLAND	STEELWORK	2022
ALFALAVAL OLMI S.p.A.	NESTE SINGAPORE	NEXT BTL PLANT SINGAPORE	PLATE & ENCLOSURE PANEL	2022
CANNON ARTES			NR 8 SKIDS FRAME	2022
PSS NETHERLANDS (SAIPEM)	THAI OIL PUBLIC COMPANY LIMITED (TOP)	SRIRACHA REFINERY - THAILAND	AMMONIA GRID INJECTION MANIFOLDS	2022
ALFALAVAL OLMI S.p.A.	ENI	GELA - ENI	NR. 4+2 BUNDLE FRAMES	2022
HEXOL ITALY S.r.l.	HEXOL ITALY S.r.l.	MANTOVA	DESIGN / TUBE BUNDLE / TUBE BUNDLE E2174	2022
MAYEKAWA	MAYEKAWA ITALIA S.r.l.	N.D.	STEELWORK (COMPRESSOR SKID A/B, VESSEL SKID1, VESSEL SKID2)	2022
ALFALAVAL OLMI S.p.A.	ARKEMA	ITALY	HEADERS - STEELWORK - BUNDLE FRAME	2021
ALFALAVAL OLMI S.p.A.	SULZER PUMPS (UK) Ltd	KSA	STEELWORK - BUNDLE FRAME	2021
ALFALAVAL OLMI S.p.A.	HELLENIC PETROLEUM SA	GREECE	STEELWORK - BUNDLE FRAME	2021
ALFALAVAL OLMI S.p.A.	UOP LIMITED	KPO THERMAL OXIDIZEN PROJECT KAZAKHSTAN	STEELWORK	2021
ALFALAVAL OLMI S.p.A.	GAZPROM	RUSSIA	DESIGN AND 3D MODELING	2021
ALFALAVAL OLMI S.p.A.	GAZPROM	RUSSIA	BUNDLE FRAME	2021
ALFALAVAL OLMI S.p.A.	GAZPROM	RUSSIA	STEAM COIL	2021
ALFALAVAL OLMI S.p.A.	GAZPROM	RUSSIA	STEELWORK	2021
ALFALAVAL OLMI S.p.A.	REPSOL	CARTAGENA - SPAIN	STEELWORK - BUNDLE FRAME	2021
ALFALAVAL OLMI S.p.A.	MIDDLE EAST OIL REFINERY (MIDOR)	MIDOR REFINERY ALEXANDRIA	HEADERS - BUNDLE FRAME	2021
CANNON ARTES	N.D.	N.D.	SKIDS	2021
CANNON ARTES	N.D.	N.D.	NR 6 SKIDS	2021
CANNON ARTES	N.D.	N.D.	NR 8 SKIDS	2021
ENERGY DEVELOPMENT CORPORATION	N.D.	GEX 360 - 3.6 MW MINDANAO 3 (M3 BINARY) GEOTHERMAL POWER PROJECT	DESIGN AND CALCULATION OF OFFLINE BUTANE STORAGE TANK	2021
PROGETTI EUROPA & GLOBAL S.p.A.	SAIPEM FOR GREEN-STREAM	UPGRADE OF LET DOWN STATION FOR LOCAL MARKET GAS SUPPLY - LYBIA	N°3 BDV SKIDS [0310-ZX-E-60037]	2021
PROGETTI EUROPA & GLOBAL S.p.A.	SAIPEM FOR GREEN-STREAM	UPGRADE OF LET DOWN STATION FOR LOCAL MARKET GAS SUPPLY - LYBIA	N°7 PRESSURE REDUCTION SKIDS [0310-ZX-E-60036]	2021

Reference List

CLIENT:	CUSTOMER:	LOCATION:	ITEM DESCRIPTION:	YEAR
SELAS LINDE GMBH	ZEEBRUGGE	CAPACITY INCREASE AT LNG TERMINAL ZEEBRUGGE	ENGINEERING, SUPPLY OF EMBEDDED PARTS SUBMERGED COMBUSTION VAPORIZER (FOR 3 UNITS)	2021
SELAS LINDE GMBH	ZEEBRUGGE	CAPACITY INCREASE AT LNG TERMINAL ZEEBRUGGE	ENGINEERING, SUPPLY OF SUBMERGED COMBUSTION VAPORIZER (FOR 3 UNITS)	2021
SIIRTEC NIGI	ENPPI	SULPHUR RECOVERY UNIT FOR ASSIUT REFINERY COMPLEX	INCINERATOR STACK	2021
STI SERVIZI TECNICI INDUSTRIALI S.r.l.	N.D.	N.D.	NR. 4 VESSELS IN 316L	2021
VERGAENGINEERING S.p.A.	ENPPI	EGYPTIAN NATURAL GAS COMPANY (GASCO) ELTESEEN STREET ,5TH COMPOUND NEW CAIRO, CAIRO, EGYPT	HEATERS 505-H-01 A/B	2021
ALFALAVAL OLMI S.p.A.	COBRA	ALGERIA	NR. 94 BUNDLE FRAME	2020
ALFALAVAL OLMI S.p.A.	NESTE SINGAPORE PTE LTD	NEXBTL PLANT - SINGAPORE	CORRUGATED SHEETS	2020
ALFALAVAL OLMI S.p.A.	MOTOR OIL HELLAS	NEW NAPHTHA PROCESSING COMPLEX CORINTH GREECE	STEELWORK ITEM 01/02/03/08/09/10	2020
ALFALAVAL OLMI S.p.A.	MOTOR OIL HELLAS	NEW NAPHTHA PROCESSING COMPLEX CORINTH GREECE	STEELWORK ITEM 11/12	2020
ALFALAVAL OLMI S.p.A.	FORMOSA PETRO-CHEMICAL CO	MAI LIAO	NR. 10 HEADERS	2020
ALFALAVAL OLMI S.p.A.	UOP LIMITED	KPO THERMAL OXIDIZEN PROJECT KAZAKHSTAN	NR. 4 TUBE BUNDLE FRAME	2020
ALFALAVAL OLMI S.p.A.	BAT MEDIAS S.A.	DANES MODERNIZATION - ROMANIA	STEEL STRUCTURES FOR AIR COOLER	2020
ALFALAVAL OLMI S.p.A.	MOTOR OIL HELLAS	NEW NAPHTHA PROCESSING COMPLEX - CORINTH (GREECE)	STEEL STRUCTURES FOR AIR COOLER	2020
ALFALAVAL OLMI S.p.A.	REPSOL	TARRAGONA - SPAIN	STEEL STRUCTURES FOR AIR COOLER	2020
ALFALAVAL OLMI S.p.A.	NESTE	NEXBTL PLANT - SINGAPORE	STEEL STRUCTURES FOR AIR COOLER	2020
ALFALAVAL OLMI S.p.A.	KARACHAGANAK PETROLEUM OPERATING B.V.	KAZAKHSTAN	STEEL STRUCTURES FOR AIR COOLER	2020
ALFALAVAL OLMI S.p.A.	BOREALIS	KALLO BELGIUM	TUBE BUNDLE FRAME	2020
FBM-HUNDSON ITALIANA S.p.A.	TECHNIPFMC	ALEXANDRIA - EGYPT	PROTECTION AND MACHINERY	2020
FBM-HUNDSON ITALIANA S.p.A.	ENPPI	MIDOR REFINERY EXPANSION - ALEXANDRIA, EGYPT	STEEL STRUCTURES FOR AIR COOLER	2020
PSS Netherlands B.V	Thai Oil Public Company Limited (TOP)	SRIRACHA REFINERY - THAILAND	AMMONIA INJECTION GRIDS	2020
QATAR FERTILIZER COMPANY (QAFCO)	QATAR FERTILIZER COMPANY (QAFCO)	QATAR	NO 8 AIR HEATERS	2020

Reference List

CLIENT:	CUSTOMER:	LOCATION:	ITEM DESCRIPTION:	YEAR
RAFFINERIA DI MILAZZO	RAFFINERIA DI MILAZZO	RAFFINERIA DI MILAZZO	VESSEL AND FLOATING HEAD	2020
ALFALAVAL OLMI S.p.A.	TENGIZCHEVROIL (TCO)	TENGIZ - KAZAKHSTAN	TUBE BUNDLE FRAME ITEM 2902	2019
ALFALAVAL OLMI S.p.A.	CEPSA	GIBRALTAR - SAN ROQUE (CADIZ) SPAIN	STEELWORK	2019
ALFALAVAL OLMI S.p.A.	TUPRAS	IZMIT REFINERY TURKEY	NR 4 TUBE BUNDLES AND FRAME	2019
ALFALAVAL OLMI S.p.A.	BASHNEFT	RUSSIA	STEELWORK - NR 12 TUBE BUNDLE - STEAM COIL	2019
ALFALAVAL OLMI S.p.A.	CEPSA	SAN ROQUE - SPAIN	TUBE BUNDLE FRAME	2019
ALFALAVAL OLMI S.p.A.	CEPSA	GIBRALTAR SAN ROQUE (CADIZ) - SPAIN	STEELWORK	2019
ALFALAVAL OLMI S.p.A.	TUPRAS IZMIT REFINERY	IZMIT REFINERY TURKEY	NR.2 TUBE BUNDLE FRAME	2019
ALFALAVAL OLMI S.p.A.	SAIPEM S.p.A.	CEC BoP Phase II - CONGO	BOLTS & PLATES	2019
FBM-HUNDSON ITALIANA S.p.A.	CHIYODA	ZIRKU ISLAND - UNIT 400	STEEL STRUCTURES FOR AIR COOLER	2019
FBM-HUNDSON ITALIANA S.p.A.	N.D.	N.D.	BUNDLE FRAME - INTERNAL PARTS - TRANSPORT BEAMS	2019
KIRCHNER ITALIA -ITALY-	TECHNIP	ALEXANDRIA - EGYPT	NR. 2 INTERMEDIATE END TUBE SHEETS	2019
KIRCHNER ITALIA -ITALY-	PETKIM PETROKIMINA A.S.	ALIAGA COMPLEX - TURKEY	FINNING TUBE	2019
KIRCHNER ITALIA -ITALY-	INDENI - PETROLEUM REFINERY CO. LTD	BWANA MKUBWA NDOLA - ZAMBIA	N. 2 AIR COOLER TUBE BUNDLES Items EA-115 E/F - ELECTRICAL ACCESSORIES	2019
KIRCHNER ITALIA -ITALY-	INDENI - PETROLEUM REFINERY CO. LTD	NDOLA REFINERY ZAMBIA	N. 1 AIR COOLER TUBE BUNDLES ITEM 308	2019
KIRCHNER ITALIA -ITALY-	INDENI - PETROLEUM REFINERY CO. LTD	BWANA MKUBWA NDOLA - ZAMBIA	N. 2 AIR COOLER TUBE BUNDLES ITEMS EA-115 E/F - ELECTRICAL ACCESSORIES	2019
KIRCHNER ITALIA -ITALY-	QAFCO	QATAR	PREFABRICATION OF NO 2 WHRS BUNDLES IN P91	2019
KIRCHNER ITALIA -ITALY-	SNAMPROGETTI / IBN ZAHR MTB2 COMPLEX	AL JUBAIL - SAUDI ARABIA	COIL PREFABRICATION AND ASSEMBLY WITH PACKING	2019
KT-KINETICS TECHNOLOGY	N.D.	N.D.	ANCHORS K355	2019
MCDERMOTT	TOYO ENGINEERING	UST-KUT IRKUTSK RUSSIA	RADIANT STEEL STACK MATERIAL & PREFABRICATION	2019
MECDERMOTT TECHNOLOGY	MECDERMOTT TECHNOLOGY LUMMUS HEAT TRANSFER	POLYMER PLANT - RUSSIA	RADIANT STEEL STACK MATERIAL	2019
PEG	N.D.	N.D.	SPARE PART AIR COOLER PE12015	2019
QATAR FERTILIZER COMPANY (QAFCO)	N.D.	N.D.	SPARE PART PER QAFCO	2019
SELAS LINDE GMBH	KEMEROVO HMU3	RUSSIA	CONVECTION SECTION MODULES, FINNING OF PIPES, HEADERS & PIGTAILS - KEMEROVO	2019
SELAS LINDE GMBH	PORVOO, LE NESTE OIL	PORVOO - FINLAND	NO 3 CONVECTION MODULE PREFABRICATION	2019

Reference List

CLIENT:	CUSTOMER:	LOCATION:	ITEM DESCRIPTION:	YEAR
SELAS LINDE GMBH	NIZHNEKAMSKNEFT-EKHIM	NEO OLEFIN COMPLEX OF OAO NIZHNEKAMSKNEFTEKHIM NIZHNEKAMSK - RUSSIA	STEEL STRUCTURE, CONVECTION SECTION MODULES AND RADIANT SECTION COIL FOR HAD E TAR HEATER	2019
SELAS LINDE GMBH	NIZHNEKAMSKNEFT-EKHIM	NEO OLEFIN COMPLEX OF OAO NIZHNEKAMSKNEFTEKHIM NIZHNEKAMSK - RUSSIA	ENGINEERING, SUPPLY OF STEEL STRUCTURE, COMBUSTION CHAMBER AND STACK FOR THE INCINERATOR	2019
ALFALAVAL OLMI S.p.A.	DI POLYMER ARIAN COMPANY	ARIAN METHANOL PLANT-ASSALUYEH-IRAN	Nr. 10 HEAT EXCHANGERS	2018
ALFALAVAL OLMI S.p.A.	SAIPEM S.p.A	CEC BoP PASE II	NR 4 TUBE BUNLDE FRAMES	2018
ALFALAVAL OLMI S.p.A.	HOWDEN	OMAN	NR 4 TUBE BUNLDE FRAMES	2018
ALFALAVAL OLMI S.p.A.	NASH - GARDNER	RAS TANURA - SAUDI ARABIA	TUBE BUNDLE FRAMES, STRUCTURAL STEELWORKS AND LIFTING BEAM	2018
ALFALAVAL OLMI S.p.A.	PROCESS SYSTEMS	LUSSAGNET - FRANCE	HEADERS PREFABRICATION AND TUBE BUNDLE ASSEMBLY INCLUDING STRUCTURES AND RUNNING TEST EXECUTION	2018
ALFALAVAL OLMI S.p.A.	SIAD	RUSSIA	STEELWORK	2018
FBM-HUNDSON ITALIANA S.p.A.	NIGERIAN NATIONAL PETROLEUM	KADUNA REFINERY	BUNDLE FRAME	2018
FBM-HUNDSON ITALIANA S.p.A.	GALP	MATOSINHOS	BUNDLE FRAME - PANEL - FAN RING	2018
KIRCHNER ITALIA -ITALY-	THYSSENKRUPP UHDE	2200/3900 MTPD AMMONIA/UREA PLANT BRUNEI FERTILIZER COMPANY	NO 5 WHRU MODULES	2018
KIRCHNER ITALIA -ITALY-	INDENI - PETROLEUM REFINERY CO. LTD	Ndola Refinery Zambia	NR. 2 TUBE BUNDLE FRAME	2018
KIRCHNER ITALIA -ITALY-	OLTIN YO'L GTL - HYUNDAI ENGINEERING & CO	UZBEKISTAN	LONGITUDINAL WELDING ON MANIFOLDS	2018
KIRCHNER ITALIA -ITALY-	QATARGAS	QATAR	CONVECTION MODULE	2018
KIRCHNER ITALIA -ITALY-	QATARGAS	QATAR	CONVECTION MODULE	2018
KIRCHNER ITALIA -ITALY-	THYSSENKRUPP	BRUNEI	CONVECTION BANKS	2018
KT-KINETICS TECHNOLOGY	PETROBEL / ENI S.p.a	ZOHR - EGYPT	INCINERATOR WHR PACKAGE NR 2 UNITS (PASHE2) - SCRUBBER FLUE GAS DUCT NR 2 UNITS (PASHE2)	2018
KT-KINETICS TECHNOLOGY	RABIGH REFINING & PETROCHEMICAL COMPANY	RABIGH, SAUDI ARABIA	STEAM COILS AND NOZZLES & FLUE GAS DUCT/STACK AND SUPPORTING SYSTEM	2018
KT-KINETICS TECHNOLOGY	SOCAR	AZERBAIJAN REPUBLIC	ANCHORS - REFRACTORY MATERIALS	2018
KT-KINETICS TECHNOLOGY	LUKOIL	NIZHEGOROD -RUSSIA	N° 20 AND N° 23 PRESSURE VESSELS	2018
KT-KINETICS TECHNOLOGY	RABIGH REFINING & PETROCHEMICAL COMPANY	RABIGH, SAUDI ARABIA	STEAM COILS AND NOZZLES / FLUE GAS DUCT/STACK AND SUPPORTING SYSTEM	2018
PROGETTI EUROPA & GLOBAL S.p.A.	PETRONAS	GARRAF- IRAQ	CRUDE OIL RUN DOWN AIR COOLER FOR OIL TRAIN 3, 4 AND 5	2018

Reference List

CLIENT:	CUSTOMER:	LOCATION:	ITEM DESCRIPTION:	YEAR
RAFFINERIA DI MILAZZO	RAFFINERIA DI MILAZZO	RAFFINERIA DI MILAZZO	BOILER VAPORIZER	2018
RAFFINERIA DI MILAZZO	RAFFINERIA DI MILAZZO	RAFFINERIA DI MILAZZO	COLUMN 091C01 - SCOT 1	2018
RIZZI ENGINEERING	MELAKA REFINERY	MELAKA REFINERY	STEELWORK AND ECONOMIZER	2018
RIZZI ENGINEERING	VENIRAN APADANA PETROCHEMICAL COMPANY/ PIDEC	IRAN	STEELWORK FOR STEAM REFORMER	2018
SELAS LINDE GMBH	JV of LINDE GAS and KUIBYSHEVK AZO	SAMARA - RUSSIA	CONVECTION BUNDLES PREFABRICATION	2018
SELAS LINDE GMBH	JV of LINDE GAS and KUIBYSHEVK AZO	SAMARA - RUSSIA	CONVECTION BUNDLES PREFABRICATION	2018
ALFALAVAL OLMI S.p.A.	TECHNIP	FRANCE	STEELWORK - TUBE BUNDLE 1 & 2 - LIFTING BEAM	2017
ALFALAVAL OLMI S.p.A.	MOLDOCOR FOR ROMGAZ S.A.	SIBIU GAS COMPRESSION STATION - ROMANIA	NR. 3 TUBE BUNDLE FRAME	2017
ALFALAVAL OLMI S.p.A.	TENGIZCHEVROIL (TCO)	TENGIZ - KAZAKHSTAN	NR. 8+10 TUBE BUNDLE FRAME	2017
ALFALAVAL OLMI S.p.A.	TENGIZCHEVROIL (TCO)	TENGIZ - KAZAKHSTAN	34 STRUCTURE - 17 SHORT LEGS MODULE- 17 SHORT LEGS MODULE	2017
ALFALAVAL OLMI S.p.A.	JORDAN PETROLUEM Co LTD	ZERQUA - JORDANIA	NR. 4 TUBE BUNDLE FRAME	2017
ALFALAVAL OLMI S.p.A.	TECHNIP	FRANCE	TUBE BUNDLE FRAME - HEADERS	2017
ALFALAVAL OLMI S.p.A.	TUPRAS	IZMIT REFINERY TURKEY	NR. 8 TUBE BUNDLE FRAME - HEADERS	2017
ALFALAVAL OLMI S.p.A.	TUPRAS	KIRIKKALE RAFINERY TURKEY	NR. 14 TUBE BUNDLE FRAME - HEADERS	2017
ALFALAVAL OLMI S.p.A.	MAYEKAWA ITALIA S.r.l.	ABU DABHI UAE	STEELWORK - TUBE BUNDLE FRAME 1 & 2	2017
ALFALAVAL OLMI S.p.A.	GARO	AL-HUWAIHSAH-OMAN	STEELWORK - TUBE BUNDLE FRAME 1 & 2	2017
ALFALAVAL OLMI S.p.A.	MOLDOCOR FOR ROMGAZ S.A.	SIBIU GAS COMPRESSION STATION - ROMANIA	NR. 3 TUBE BUNDLE FRAME	2017
KT-KINETICS TECHNOLOGY	Lotos Asphalt Sp. z o. o., Grupa LOTOS SA	LOTOS - POLAND	COVER OF BASIN X3	2017
KT-KINETICS TECHNOLOGY	Lotos Asphalt Sp. z o. o., Grupa LOTOS SA	LOTOS - POLAND	LOOSE MATERIAL FOR FURNACE	2017
KT-KINETICS TECHNOLOGY	Lotos Asphalt Sp. z o. o., Grupa LOTOS SA	LOTOS - POLAND	NEW DUCT STEELWORK	2017
KT-KINETICS TECHNOLOGY	PETROBEL / ENI S.p.a	ZOHR - EGYPT	HEATING COIL (ZOHR)	2017
KT-KINETICS TECHNOLOGY	RABIGH REFINING & PETROCHEMICAL COMPANY	RABIGH, SAUDI ARABIA	FINNING - MR0126001	2017
KT-KINETICS TECHNOLOGY	RABIGH REFINING & PETROCHEMICAL COMPANY	RABIGH, SAUDI ARABIA	MR0131-001 STEELWORK SUPPLY AND SHOP FABRICATION - RADIANT COIL PEFABRICATION AND CONVECTION MODULARIZATION	2017
KT-KINETICS TECHNOLOGY	N.D.	N.D.	SEAL PLATES AND HEADER BOXES	2017

Reference List

CLIENT:	CUSTOMER:	LOCATION:	ITEM DESCRIPTION:	YEAR
RAFFINERIA DI MILAZZO	RAFFINERIA DI MILAZZO	RAFFINERIA DI MILAZZO	VESSEL	2017
RAFFINERIA DI MILAZZO	RAFFINERIA DI MILAZZO	RAFFINERIA DI MILAZZO	AIR COOLER 024 EA208	2017
SELAS LINDE GMBH	PREEM GOTHENBURG SWEDEN	N.D.	CONVECTION MODULES, WHRU (W3) (W4) HEADERS & PIGTAILS	2017
STI SERVIZI TECNICI INDUSTRIALI S.r.l.	REFINERIA ISLA CURA-CAO B.V.	N.D.	NR.2 SET OF HEADERS / NR.2 SET SHELL+BODY FLANGE	2017
ACCEDE IMPIANTI ITALIA	EXXON MOBIL IRAQ LIMITED	WEST QURNA - IRAQ	HOT OIL FIRED HEATER	2016
ACCEDE IMPIANTI ITALIA	SHELL NEDERLAND RAFFINADERIJ B.V. / FLUOR B.V.	PERNIS (ROTTERDAM)	SLIDING GATES	2016
ALFALAVAL OLMI S.p.A.	TUPRAS	IZMIR, TURKEY	NR 8 TUBE BUNDLE FRAME	2016
ALFALAVAL OLMI S.p.A.	TUPRAS	IZMIR, TURKEY	NR 8 TUBE BUNDLE FRAME	2016
ALFALAVAL OLMI S.p.A.	TUPRAS	IZMIR, TURKEY	NR 10 TUBE BUNDLE FRAME	2016
ALFALAVAL OLMI S.p.A.	TENGIZCHEVROIL (TCO)	TENGIZ - KAZAKHSTAN	NR 68 TUBE BUNDLES FRAME	2016
ALFALAVAL OLMI S.p.A.	MOLDOCOR	SIBIU GAS COMPRESSION STATION - ROMANIA	TUBE BUNDLE FRAME	2016
KT-KINETICS TECHNOLOGY	LOTOS ASFALT SP. Z O. O., GRUPA LOTOS SA	GDANSK, POLAND	NR 10 AIR COOLERS	2016
KT-KINETICS TECHNOLOGY	LOTOS ASFALT SP. Z O. O., GRUPA LOTOS SA	GDANSK, POLAND	AIR COOLER	2016
KT-KINETICS TECHNOLOGY	ADCO	ABU DHABI	ANCHORS	2016
KT-KINETICS TECHNOLOGY	LOTOS ASFALT SP. Z O. O., GRUPA LOTOS SA / ADCO	GDANSK, POLAND	ANCHORS	2016
KT-KINETICS TECHNOLOGY	OAO GAZPROMNEFT REFINERY	OMSK REFINERY - RUSSIA	CONVECTION MODULE	2016
KT-KINETICS TECHNOLOGY	EFRA PROJECT HVDU - GRUPA LOTOS S.A.	GDANSK, POLAND	HYDROWAX VACUUM DISTILLATION UNIT (HVDU)	2016
KT-KINETICS TECHNOLOGY	TECNIMONT, OSJC EuroChem	KINGISEPP (RUSSIAN FEDERATION)	STAR-UP HEATER AND ANCHORS FOR REFORMER	2016
KT-KINETICS TECHNOLOGY	PETROBEL	ZOHR - EGYPT	INCINERATOR WHR (NR 2 UNITS)	2016
KT-KINETICS TECHNOLOGY	EUROPEAN UNION FP07	BORG AL ARAB, EGYPT	BACK-UP SYSTEM MATS - MULTIPURPOSE APPLICATIONS BY THERMODYNAMICS SOLAR	2016
ALFALAVAL OLMI S.p.A.	CONFID FOR ROMGAZ SA	ROMGAZ STATION - ROMANIA	NR. 48 TUBE BUNDLE FRAME - STEELWORK - LOUVERS	2015
ALFALAVAL OLMI S.p.A.	GEA REFRIGERATION ITALY SPA	ROCK SPRINGS - WYOMING - USA	STEELWORK FOR AIR COOLER - TUBE BUNDLES FRAME	2015
ALFALAVAL OLMI S.p.A.	MOLDOCOR	SIBIU & WEST GAS COMPRESSION STATION - ROMANIA	STEELWORK FOR AIR COOLER - TUBE BUNDLES FRAME	2015
ALFALAVAL OLMI S.p.A.	NESTE OIL	NESTE OIL OYJ PORVOO REFINERY-FINLAND	STEELWORK FOR AIR COOLER	2015
KIRCHNER ITALIA -ITALY-	CHIYODA - TECHNIP JOINT VENTURE	RAS LAFFAN - QATAR	CONVECTION	2015

Reference List

CLIENT:	CUSTOMER:	LOCATION:	ITEM DESCRIPTION:	YEAR
KIRCHNER ITALIA -ITALY-	SAIPEM, ARAMCO OVERSEAS COMPANY & SUMITOMO CHEMICAL	RABIGH, SAUDI ARABIA	SUPPLY OF STACK FOR HEATERS R420-FR-2511 / R410-FR-1311/21/31/41	2015
KIRCHNER ITALIA -ITALY-	PDVSA (PETROLERA SINOVERSA S.A.)	JOSE REF. - VENEZUELA	N. 2 AIR COOLED HEAT EXCHANGERS	2015
KT-KINETICS TECHNOLOGY	SAIPEM for SAUDI ARAMCO	JAZAN - ARABIA SAUDITA	HPSS CONVECTION NR 3 UNITS J-30 + NO 3 UNITS A-07	2015
ALFALAVAL OLMI S.p.A.	NESTE OIL	NESTE OIL OYJ PORVOO REFINERY-FINLAND	LOUVERS	2015
ALFALAVAL OLMI S.p.A.	SADARA	JUBAIL KSA, RAS TANURA - SAUDI ARABIA	STEELWORK FOR AIR COOLER	2014
ALFALAVAL OLMI S.p.A.	TUPRAS	OAR HYDROCRACKING PROJECT	NR 4 TUBE BUNDLE FRAMES	2014
ALFALAVAL OLMI S.p.A.	ENPPI / Khalda Petroleum Company	WESTERN DESERT - EGYPT	NR 16 TUBE BUNDLE FRAMES - PROTECTION IN SS	2014
ALFALAVAL OLMI S.p.A.	ROSNEFT	RUSSIA	STEELWORK FOR AIR COOLER	2014
ALFALAVAL OLMI S.p.A.	TUPRAS	IZMIR, TURKEY	N° 8 AIR COOLER FABRICATION AND ASSEMBLY	2014
ALFALAVAL OLMI S.p.A.	EGYPTIAN REFINING COMPANY (TAKRIR) S.A.E (ERC)	MOSTOROD, ARAB REPUBLIC OF EGYPT	NR 7 TUBE BUNDLE FRAMES - STEELWORK FOR AIR COOLER	2014
EXERGY	N.D.	TARGOVISHTE - BULGARY	NR 6 TUBE BUNDLE FRAMES	2014
EXERGY	N.D.	TARGOVISHTE - BULGARY	STEELWORK FOR AIR COOLER	2014
FOSTER WHEELER	RAFFINERIA DI MILAZZO	RAFFINERIA DI MILAZZO	N. 2 AIR COOLED HEAT EXCHANGERS	2014
KIRCHNER ITALIA -ITALY-	SASOL	RAFFINERIA SARROCH - ITALY	CONVECTION	2014
KIRCHNER ITALIA -ITALY-	PTT	SARROCH	PIPING	2014
KIRCHNER ITALIA -ITALY-	JGCS	VIETNAM	END TUBE SHEETS	2014
KIRCHNER ITALIA -ITALY-	UHDE / THYSSENKRUPP	RAS EL KHAIR - SAUDI ARABIA	CONVECTION BANKS 03B002	2014
KIRCHNER ITALIA -ITALY-	RAFFINERIA DI MILAZZO	RAFFINERIA DI MILAZZO	HEATERS: TOPPING 3 & VACUUM	2014
RAFFINERIA DI MILAZZO	RAFFINERIA DI MILAZZO	RAFFINERIA DI MILAZZO	CONVERTER	2014
SAMIR	SAMIR	MAROCCO	SPARE PARTS FOR HEATERS	2014
SELAS LINDE GMBH	JV of LINDE GAS and KUIBYSHEVK AZO	TOGLIATTI - RUSSIA	WHRU MODULARIZATION	2014
SELAS LINDE GMBH	CONSORTIUM ADHI - GS&EC	PT. PERTAMINA (PERSERO) INDONESIA	PIGTAILS	2014
ALFALAVAL OLMI S.p.A.	TECHNIP ITALY S.p.A. / LUKOIL NEFTOCHIM BOURGAS	LUKOIL NEFTOCHIM BOURGAS	NR 16 TUBE BUNDLE FRAMES FABRICATION AND ASSEMBLY	2013
FBM-HUNDSON ITALIANA S.p.A.	FLUOR FOR TCO (TEN-GIZCHEVROIL)	KAZAKHISTAN	STEELWORK FOR AIR COOLER	2013
FBM-HUNDSON ITALIANA S.p.A.	TOTAL - PROSERMAT	KHARYGA PROJECT - RUSSIA	STEELWORK FOR AIR COOLER	2013

Reference List

CLIENT:	CUSTOMER:	LOCATION:	ITEM DESCRIPTION:	YEAR
HAMON D'HONDT S.A.	SAUDI ELECTRICITY COMPANY / ARABIAN BEMCO CONTACTING CO.LTD	RIYADH CITY, KINGDOM OF SAUDI ARABIA	N. 80 FABRICATION HEADERS	2013
KIRCHNER ITALIA -ITALY-	PDVSA (PETROLERA SINOVERSA S.A.)	JOSE REF. - VENEZUELA	N. 9 AIR COOLED HEAT EXCHANGERS	2013
KIRCHNER ITALIA -ITALY-	INDENI - PETROLEUM REFINERY CO. LTD	BWANA MKUBWA NDOLA - ZAMBIA	N. 9 TUBE BUNDLES	2013
KIRCHNER ITALIA -ITALY-	SNAM PROGETTI - EMICHEN AMIC	GELA REFINERY	TUBE SHEETS & COILS PREFABRICATION	2013
KIRCHNER ITALIA -ITALY-	ENI SPA	DANGOTE FERTILIZER PROJECT - NIGERIA	STEELWORK DETAILS	2013
KIRCHNER ITALIA -ITALY-	SABIC - SAUDI BASIC INDUSTRIES CORPORATION	IBN AI - BAY TAR NATIONAL CHEMICAL FERTILIZER	NR 8 TUBE SHEETS & NR 2 REMOVABLE PANELS - FABRICATION COIL & MANIFOLD	2013
KIRCHNER ITALIA -ITALY-	CITGO PETROLEUM CORPORATION	MIAMI - USA	NR 218 PIGTAIL PREFABRICATION	2013
KIRCHNER ITALIA -ITALY-	SARAS	SARROCH (CAGLIARI) - ITALIA	DUCTS	2013
PROGETTI EUROPA & GLOBAL S.p.A.	SCOP	IRAQ	TANKS (Nr 2 FUEL OIL ITEM 230-TK-01 A/B & Nr 1 FIRE WATER ITEM 290-TK-01)	2013
PROGETTI EUROPA & GLOBAL S.p.A.	SCOP	IRAQ	Nr 4 VESSELS - ITEMS250-V-01/02/03 & 260-V-01	2013
RAFFINERIA DI MILAZZO	RAFFINERIA DI MILAZZO	RAFFINERIA DI MILAZZO	N. 4 AIR COOLED HEAT EXCHANGERS	2013
RAFFINERIA DI MILAZZO	RAFFINERIA DI MILAZZO	RAFFINERIA DI MILAZZO	AIR COOLED HEAT EXCHANGERS	2013
RAFFINERIA DI MILAZZO	RAFFINERIA DI MILAZZO	RAFFINERIA DI MILAZZO	N. 2 AIR COOLED HEAT EXCHANGERS	2013
SELAS LINDE GMBH	GEOS-ROSENEFT	NOVOKUIBYSHEVSK	HEADERS AND PIGTAILS FOR H2 REFORMER	2013
SELAS LINDE GMBH	GEOS-ROSENEFT	NOVOKUIBYSHEVSK	WHRU MODULES FOR H2 REFORMER	2013
TECNIMONT ITALIA S.p.A.	RAFFINERIA DI MILAZZO	RAFFINERIA DI MILAZZO	MP STEAM SUPERHEATER (ITEM 095-E-010) AND FLUE GAS DUCT	2013
ALFALAVAL OLMI S.p.A.	PETROLEUM DEVELOPMENT OMAN	OMAN	NR. 3 AIR COOLER FABRICATION AND ASSEMBLY	2012
FBM-HUNDSON ITALIANA S.p.A.	PETRONAS MLNG TIGA - JGC CORPORATION	LNG Tiga - MALAYSIA	STEELWORK FOR AIR COOLER	2012
FBM-HUNDSON ITALIANA S.p.A.	PETROBRAS	COMPLEXO PETROQUÍMICO DO RIO DE JANEIRO, BRASIL	STEELWORK FOR AIR COOLER	2012
FBM-HUNDSON ITALIANA S.p.A.	PETROFAC / TOTAL / CAMERON	LAGGAN TORMORE PROJECT	STEELWORK FOR AIR COOLER	2012
HAMON D'HONDT S.A.	PETROBRAS	ITABORAI, RIO DE JANEIRO, BRASIL	N° 181 MANIFOLD FOR AIR COOLERS FABRICATION	2012
HAMON D'HONDT S.A.	PETROBRAS	CARTEIRA DE DIESEL NA RPBC (SP)	N° 94 MANIFOLD FOR AIR COOLERS FABRICATION	2012
KIRCHNER ITALIA -ITALY-	SEPANIR/PARS OIL & GAS	ASSALUYEH, IRAN	N°6 HEATERS	2012
KIRCHNER ITALIA -ITALY-	PEG - Progetti europa & Global S.p.A.	ZUBAIR DEGASSING STATION - IRAQ	N° 6 CRUDE OIL HEATERS	2012

Reference List

CLIENT:	CUSTOMER:	LOCATION:	ITEM DESCRIPTION:	YEAR
LINDE IMPIANTI ITALIA	RAFFINERIA DI MILAZZO S.P.A.	RAFFINERIA DI MILAZZO	PREFABRICATION FLUE GAS PIPING	2012
Progetti Europa & Global S.p.A.	SCOP - STATE COMPANY FOR OIL PROJECT	AL HABANEYA, IRAQ	ATMOSPHERIC TANK	2012
PROGETTI EUROPA & GLOBAL S.p.A.	WEATHERFORD OIL TOOL MIDDLE EAST (WOTME)	ZUBAIR, IRAQ	N° 6 AIR COOLER HEAT EXCHANGERS FABRICATION AND ASSEMBLY	2012
TECNIMONT ITALIA S.p.A.	KUWAIT NATIONAL PETROLEUM COMPANY	MAA Refinery - KUWAIT	N° 2 STACK (ITEMS: S 223-001 & S 224-001)	2012
TECNIMONT ITALIA S.p.A.	KHABAROVSK OIL REFINERY	KHABAROVSK	N° 1 STACK (ITEM: F 2602-S1) & N° 1 INCINERATOR (ITEM: F 2602-F1)	2012
VERGAENGINEERING S.p.A.	MOTOR OIL HELLAS	CORINTH REFINERY, GREECE	VISBREAKER HEATER - ITEM F-151	2012
ALFALAVAL OLMI S.p.A.	FORMOSA PETRO-CHEMICAL CORP	MAI LIANO-TAIWAN	AIR COOLERS FABRICATION AND ASSEMBLY	2011
ALFALAVAL OLMI S.p.A.	TURBODEN	KIRCHSTOCKACH GEOTHERMAL POWER PLANT - GERMANY	N° 42 AIR COOLERS FABRICATION AND ASSEMBLY	2011
ALFALAVAL OLMI S.p.A.	GEA REFRIGERATION ITALY - STEG	REFROIDISSEUR GAZ DE REGENERATION - TUNISIA	TUBE BUNDLE FRAMES FABRICATION AND ASSEMBLY	2011
ALFALAVAL OLMI S.p.A.	SARAS SPA	T2 - RAFFINERIA DI SARROCH (CA)	AIR COOLER FRAME FABRICATION	2011
ALFALAVAL OLMI S.p.A.	JSC ACRON (FOR 7687) DOROGOBUZH OJSC (FOR 7688)	NOVGOROD - RUSSIAN (FOR 7687) VERKHNE-NEPROVSKY - RUSSIAN (FOR 7688)	N° 4 AIR COOLER FABRICATION - HIGH PRESSURE (465 BAR)	2011
I.T.T. S.p.A.	EUROPLASMA - CHO-POWER PROJECT	MORCENX (BORDEAUX FRANCE)	STEELWORK CONVECTION COIL FABRICATION	2011
KIRCHNER ITALIA -ITALY-	UHDE	IOCL REFINERY, PARADIP, INDIA	CONVECTION BANKS	2011
KIRCHNER ITALIA -ITALY-	SEPANIR	ASSALUYEH, IRAN	N°8 DRIERS REGENERATION HEATERS	2011
LINDE IMPIANTI ITALIA	RAFFINERIA DI MILAZZO S.C.P.A.	RAFFINERIA DI MILAZZO	CONVECTION MODULE	2011
OLMI S.p.A - ITALY	TURBODEN	SAUERLACH - GERMANY	N° 36 AIR COOLER FABRICATION AND ASSEMBLY	2011
VERGAENGINEERING S.p.A.	PETROJECT FOR G.P.C.	CRUDE OIL TREATMENT PLANT - RAS BAKR - EGYPT	COIL AND STEELWORK FABRICATION HEATER N°1	2011
VERGAENGINEERING S.p.A.	ENPPI for ANRPC	NEW NAPHTHA HYDROTREATING UNIT DIRECT FIRED HEATERS PACKAGE ALEXANDRIA - EGYPT	COIL AND STEELWORK FABRICATION HEATERS N° 3	2011
VERGAENGINEERING S.p.A.	COSTAIN OIL AND GAS LTD.	YORK EASINGTON TERMINAL WORKS, EASINGTON (UK)	HEATER H-091	2011
VERGAENGINEERING S.p.A.	TOWELL & CO. FOR GPS FOR Oxy	WADI LATHAM - OMAN	HEATER 09-H-9043	2011
ALFALAVAL OLMI S.p.A.	KUWAIT NATIONAL PETROLEUM COMPANY	MINA AL_ALMADI	BUNDLE FRAME FABRICATION	2010
KIRCHNER ITALIA -ITALY-	POLIMERI EUROPA	PRIOLO (SR) - ITALY	A.P.H. SYSTEM FOR HEATER B-001 UNIT - CR-23	2010

Reference List

CLIENT:	CUSTOMER:	LOCATION:	ITEM DESCRIPTION:	YEAR
KIRCHNER ITALIA -ITALY-	ENI - POLIMERI EUROPA	IMPIANTO ETILENE - PRIOLO (SR)	QUENCH FITTING	2010
KIRCHNER ITALIA -ITALY-	ENI S.p.A. DIVISIONE REFINERING & MARKETING	SANNAZZARO DE' BURGONDI (PV) -ITALY	RADIANT COIL	2010
KIRCHNER ITALIA -ITALY-	ENI - POLIMERI EUROPA	IMPIANTO ETILENE-PRIOLO (SR)	SEAL PLATES AND HEADER BOXES	2010
OLMI S.p.A - ITALY	RENCO S.p.A. - FLUXYS	BERNEAU COMPRESSION STATION - BELGIUM	N° 8 TUBE BUNDLES FRAME (ITEM: E-411060/E-412060/E-414060)	2010
TECHNIP K.T.I.	SNEP EDC	SAMIR CDU4 PROJECT CRUDE HEATER MOHAMMEDIA - MAROCCO	CONVECTION SECTION MODULARIZATION - RADIANT COIL PREFABRICATION	2010
TECHNIP K.T.I.	SNEP EDC	SNEP EDCMOHAMMEDIA REFINERY - MAROCCO	CONVECTION SECTION & RADIANT COIL PREFABRICATION EDC CRACKING FURNANCE	2010
TECHNIP K.T.I.	SNEP EDC	SNEP EDCMOHAMMEDIA REFINERY - MAROCCO	STEELWORK FOR EDC CRACKING FURNANCE	2010
TECHNIP K.T.I.	TECNICAS REUNIDAS/ SAUDI ARAMCO TOTAL REFINING AND PETROCHEMICAL COMPANY (SATORP)	JUBILAN EXPORT REFINERY	TRANSFER LINE PREFABRICATION	2010
HYDROCHEM	LUDAN ENG.	STEAUVA REFINERY - CAMPINA ROMANIA	REFORMER	2009
KIRCHNER ITALIA -ITALY-	RAFFINERIA DI MILAZZO SPA	095 AREA ZOLFI RAFFINERIA DI MILAZZO -ITALY	095-ST-001 STACK	2009
KIRCHNER ITALIA -ITALY-	SEPANIR/PARS OIL & GAS	ASSALUYEH - IRAN	N°4 DRIERS REGENERATION HEATERS	2009
LINDE IMPIANTI ITALIA	CONSORCIO ALUSA-GALVAO-TOME - PETROBRAS/RLAM'	LANDULPHO ALVES MATARIPE - RLAM REFINERY - BRASIL	CONVECTION MODULES	2009
LINDE IMPIANTI ITALIA	NIOEC	SHAZAND ARAK REFINERY EXPANSION AND UPGRATING PROJECT - NATIONAL IRANIAN OIL REFINING	RADIANT COIL PREFABRICATION	2009
LINDE IMPIANTI ITALIA	NIOEC	SHAZAND ARAK REFINERY EXPANSION AND UPGRATING PROJECT - NATIONAL IRANIAN OIL REFINING	CONVECTION SECTION	2009
LINDE IMPIANTI ITALIA	PETROBRAS	HYDROGEN GENERATION UNIT U-34 - UGH	REFORMER B-3401 - CONVECTION SECTION	2009
OLMI S.p.A - ITALY	NESTE OIL TECHNIP ITALY S.p.A.	NEXBLT PLANT - NETHERLANDS	AIR COOLER	2009
OLMI S.p.A - ITALY	ALSTON POWER	FOSSIL POWER PLANT-KARLSRUE RDK8	NR° 4 DUPLEX HEATERS	2009
OLMI S.p.A - ITALY	UHDE GmbH	SLUISKIL	COOLING WATER AIR COOLER	2009

Reference List

CLIENT:	CUSTOMER:	LOCATION:	ITEM DESCRIPTION:	YEAR
PROGETTI EUROPA & GLOBAL S.p.A.	MINISTRY OF OIL/ SOUTH OIL COMPANY (S.O.C.)	CRUDE OIL PROCESS PLANTS PACKAGES FOR DEGASSING STATION - NAHAR BIN UMMAR, IRAQ	ATMOSPHERIC STORAGE TANK	2009
PROGETTI EUROPA & GLOBAL S.p.A.	MINISTRY OF OIL/ SOUTH OIL COMPANY (S.O.C.)	REFORMER B-3401	INCENERITOR & STACK	2009
PROGETTI EUROPA & GLOBAL S.p.A.	MINISTRY OF OIL/ SOUTH OIL COMPANY (S.O.C.)	CRUDE OIL PROCESS PLANTS PACKAGES FOR DEGASSING STATION - NAHAR BIN UMMAR, IRAQ	AIR COOLER	2009
PROGETTI EUROPA & GLOBAL S.p.A.	MINISTRY OF OIL/ SOUTH OIL COMPANY (S.O.C.)	NOHAR BIN UNMAR (IRAQ)	DEHYDRATION & DESALTING VESSELS AND OVERHEAD SEP- ARATORS	2009
PROGETTI EUROPA & GLOBAL S.p.A.	MINISTRY OF OIL/ SOUTH OIL COMPANY (S.O.C.)	IRAQ	NR 4 TEST TANKS	2009
SAIPEM	QAFCO	QAFCO 6 PROJECT QATAR	N°4 GRANULATOR FLUIDIZA- TION AIR HEATER AND N°1 GRANULATOR FLUIDIZATION AIR HEATER	2009
SNAMPROGETTI S.p.A.	QAFCO	QAFCO 5 PROJECT	Nr.5 AIR HEATERS	2009
TECHNIP K.T.I.	GRUPA LOTOS	GDNSK REFINERY-BU- TANE DEASHLTING SDA/ROSE PROJECT HOT OIL UNIT	RADIANT AND CONVECTION COILS	2009
VERGAENGINEERING S.p.A.	HEL.PE. - THESSALON- IKI	THESSALONIKI REFIN- ERY GREECE	HEATERS F-150/F-103/F-1401- 02-03/F-1404	2009
VERGAENGINEERING S.p.A.	ENPPI for GASCO	EGYPT	N°2 REGENERATION GAS HEATER	2009
VERGAENGINEERING S.p.A.	ENPPI for PETROBEL	AL DEKHILAH ALEX- ANDRIA, EGYPT	N°3 HEATERS	2009
VERGAENGINEERING S.p.A.	ENPPI for E-STYRENICS	AL DEKHILAH ALEX- ANDRIA, EGYPT	HEATER 500-H-001	2009
HYDROCHEM	PETROTEL - LUKOIL	PLOIESTI - ROMANIA	REFORMER	2008
HYDROCHEM	BERNBURG	GERMANIA	REFORMER	2008
KIRCHNER ITALIA -ITALY-	TECHINT	EMETHANEX - DAMI- ETTA, EGYPT	UNIT 1H-0301 PRIMARY RE- FORMER	2008
OLMI S.p.A - ITALY	NESTE OIL TECHNIP ITALY S.p.A.	NEXBLT PLANT - SIN- GAPORE	AIR COOLER	2008
OLMI S.p.A - ITALY	ALSTOM POWER	CSA ATLANTIC STEEL - BRAZIL	DUMP CONDENSER	2008
OLMI S.p.A - ITALY	TECHNIP BENELUX FOR CEPSA S.A.	ANT HUELVA - SPAIN	STEAM DRUM	2008
RENCO	COMPRA ENERGY S.A.	BAKU AZERBAIJAN	DECK INTERFACE BEOMPRES- SOR SKIDSAMS AND PLATES FOR BOP AND COMPRESSOR SKIDS	2008
TECHNIP K.T.I.	GRUPA LOTOS S.A.	GDANSK REFINERY UPGRADE - POLAND	AIR COOLER	2008
TECHNIP K.T.I.	LURGI - GRUPA LOTOS S.A.	POLAND	UNIT 0120 CRUDE OIL DISTILLA- TION II	2008

Reference List

CLIENT:	CUSTOMER:	LOCATION:	ITEM DESCRIPTION:	YEAR
GEA BTT	CNIM	THERMOVALORIZATION PLANT FOR AUTHONOMY OF MARSEILLE / FOS-SUR-MER-FRANCE	NR 2 STEAM MANIFOLDS	2007
KIRCHNER ITALIA -ITALY-	CPECC	PROJECT TOPPING DE CONDENSAT - SKIKDA - ALGERIA	HEATER F-101, F-102, F-103	2007
KIRCHNER ITALIA -ITALY-	METHANOL CASALE S.A. FOR ATLANTIC METHANOL PRODUCTION COMPANY L.L.C.	EQUATORIAL GUINEA	PREFORMER HEATER F-203	2007
KIRCHNER ITALIA -ITALY-	JACOBS/ TOTAL S.A.	IMMINGHAM REFINERY - U.K.	REACTOR HEATER 11F-01	2007
LINDE IMPIANTI ITALIA	PETROBRAS	URL III PLANGAS TEN-GAS TECAB - CABI-UNAS - BRAZIL	HEATER F-21001 & F-21002	2007
VERGAENGINEERING S.p.A.	PETROFAC	HASDRUBAL TERMINAL - TUNISIA	SUPPLY OF FIRED HEATER HOT OIL PACKAGE	2007
VERGAENGINEERING S.p.A.	JACOBS	BP RAFFINADERIJ ROTTERDAM	CHARGE HEATER ITEM: H-301	2007
KIRCHNER ITALIA -ITALY-	TECHNIP FRANCE	DUNG QUAT/VIETNAM	RADIANT END CONVECTION COIL FOR STRIPPER REBOILER HEATER H-1201, H-1202, 1301/2/3/4	2006
KIRCHNER ITALIA -ITALY-	HELLENIC PETROLEUM SA.	ASPROYRGOS ATTIKA (GREECE)	CDHDS-REBOILER HEATER L-9201	2006
KIRCHNER ITALIA -ITALY-	ENI RAFFINERIIY - TARANTO	ENI RAFFINERIA DI TARANTO	HEATER F-4240 / F-4160 IMPIANTO HYDROCRACKING	2006
LINDE IMPIANTI ITALIA	ENI IRAN B.V. FOR NATIONAL IRANIAN OIL COMPANY (NIOC) P.E.D.E.C.	DARQUAIN OIL FIELD - IRAN	RADIANT AND CONVECTION COILS FOR 3 HEATERS	2006
LINDE IMPIANTI ITALIA	SNAMPROGETTI	SAMIR UPGRADE PROJECT - MOHAMMEDIA - MAROCCO	HEATER (ITEM: 31-H-101; 33-H-101; 34-H-102; 34-H-201) FLUE GAS DUCT	2006
SPIG	HERA S.P.A.	POTENZIAMENTO DI TERMOVALORIZZAZIONE DEL SITO GEOTERMIA - FERRARA	AIR COOLED CONDENSER	2006
SPIG	HERA S.P.A.	FORLI'	AIR COOLED CONDENSER	2006
VERGAENGINEERING S.p.A.	KELLOG BROWN & ROOT - KBR Ltd. for GUPCO PMT	FIELD DEVELOPMENT PROJECT SAQQARA - EGYPT	HOT OIL HEATER (ITEM: B-7501)	2006
ERGMED RAFFINERIE MEDITERRANEE S.p.A.	ERGMED RAFFINERIE MEDITERRANEE S.p.A.	UNITA' CR 41 IMPIANTI NORD DI PRIOLO	COMBUSTOR B-4301 AND D-4101	2005
ERGMED RAFFINERIE MEDITERRANEE S.p.A.	ERGMED RAFFINERIE MEDITERRANEE S.p.A.	UNITA' CR 41 IMPIANTI NORD DI PRIOLO	CONVECTION E-4115 + DUCTS AND STEELWORK	2005
FBM-HUNDSON ITALIANA S.p.A.	TCO (TENGIZCHEVROIL)	TENGIZ CHEVROIL ASSET DEVELOPMENT PROJECT - KAZAKHSTAN	AIR COOLED HEAT EXCHANGERS	2005
GEA BTT	CRYSTAL - G.E. THERMODYN - MALAPERT ZELLER	USINE D'INCINERATION DE DIJON	STEAM MANIFOLD	2005
HYDROCHEM	DELFIJL NETHERLANDS	DELFIJL NETHERLANDS	NR 2 REFORMER WITH COM-MONT DUCT	2005

Reference List

CLIENT:	CUSTOMER:	LOCATION:	ITEM DESCRIPTION:	YEAR
JOHN ZINK LLC	COSTAIN OIL AND GAS LTD.	VAPOR RECOVERY UNIT PROJECT TEESSIDE - UNITED KINGDOM	NR 12 PRESSURE VESSELS	2005
KIRCHNER ITALIA -ITALY-	METHANOL CASALE S.A. FOR ATLANTIC METHANOL PRODUCTION COMPANY L.L.C.	EQUATORIAL GUINEA	PREFORMER HEATER F-203	2005
OLMI S.p.A - ITALY	SKANDINAVISKA RAFFINERY AB SCANRAFF	GOP PROJECT - LYSEKIL SWEDEN	AIR COOLER	2005
OLMI S.p.A - ITALY	FORTUM OIL OY	DIESEL RESIDUE HYDROCRACKING - PORVOO FINLAND	AIR COOLER	2005
RIVOIRA - PRAXAIR	RIVOIRA - PRAXAIR	RIVOIRA PLANT RAVENNA - ITALY	REFORMER HEATER	2005
TECHNIP K.T.I.	ANSALDO FUEL CELLS S.p.A.	FUEL PROCESSING SYSTEM GEBZE KOCaeli - TURKEY	CONVECTION FOR PROCESS SKID	2005
VERGAENGINEERING S.p.A.	ERG-MED RAFFINERIE MEDITERRANEE	RAFFINERIE ISAB PRILO GARGALLI (SR)	PREHEATER FURNACE B - 4001	2005
VERGAENGINEERING S.p.A.	ROSETTI MARINO	EL GAMIL PLANT - EGIPT	STABILIZATION REBOILER HEATER 0214 - FA-101	2005
VERGAENGINEERING S.p.A.	J&P for C.P.T.L. (COMPAGNIE DES PETROLES TOTAL LIBYE) / TOTAL	GAS DEVELOPMENT PROJECT PHASE 4 GREAT MABRUK -LIBYA	HOT OIL HEATER (ITEM: 400-H-401)	2005
FBM-HUNDSON ITALIANA S.p.A.	JGC CORPORATION	SOHAR REFINERY PROJECT - SULTANATE OF OMAN	AIR COOLER HEAT EXCHANGERS	2004
HEURTEY PETROCHEM ITALIANA	HELLENIC PETROLEUM SA -GREECE	USALDO PROJECT TESSALONIKI -GREECE-	PREHEATER FURNACE F-1901	2004
JOHN ZINK LLC	BOTAS PETROLEUM PIPELINE CORPORATION	BAKU TBILISI CEYHAN CRUDE OIL PIPELINE PROJECT	No 3 VAPOR COMBUSTION STACKS	2004
KIRCHNER ITALIA -ITALY-	SNAMPROGETTI / ABB LUMMUS MALTA / HYUNDAI AGIP GAS BV LIBYAN BRANCH -ITALY	ONSHORE PLANT MELLITAH -LIBYA	REGENERATION GAS HEATERS 51/52/53-311-FA-001	2004
TECHNIP K.T.I.	MOTOR OIL (HELLAS) CORINTH REFINERY SA	CORINTH REFINERIES - GREECE	THERMAL INCINERATOR WHB + HP STEAM SUPERHEATER ITEM 7710 + 7711	2004
TECHNIP K.T.I.	MOTOR OIL (HELLAS) CORINTH REFINERY SA	CORINTH REFINERIES - GREECE	THERMAL INCINERATOR STACK	2004
TECHNIP K.T.I.	MOTOR OIL (HELLAS) CORINTH REFINERY SA	CORINTH REFINERIES - GREECE	STEELWORK & DUCTS SYSTEM FOR TOPPING HEATER UNIT REVAMPING	2004
VERGAENGINEERING S.p.A.	ROSETTI MARINO FOR PETROBEL -ITALY	ON SHORE STABILIZATION UNIT EL-GAMIL -EGYPT	STABILIZER REBOILER 0214-FA-001-A/B	2004
VERGAENGINEERING S.p.A.	FOSTER WHEELER FOR ESSO PETROLEUM COMPANY	FAWLEY SULPHUR FREE MOGAS - UNITED KINGDOM	FEED PREHEATER FURNACE (ITEM SN-F-201)	2004
FBM-HUNDSON ITALIANA S.p.A.	KELLOG BROWN & ROOT -AZERBAIJAN-	SANGACHAL TERMINAL -AZERBAIJAN-	AIR COOLED HEAT EXCHANGERS	2003
FBM-HUNDSON ITALIANA S.p.A.	BECHTEL INTERNATIONAL -EGYPT-	IDKU - EGYPT	STEELWORK AIR COOLED HEAT EXCHANGERS	2003

Reference List

CLIENT:	CUSTOMER:	LOCATION:	ITEM DESCRIPTION:	YEAR
HAMON D'HONDT S.A.	ABB LUMMUS GLOBAL FOR EXXON NEFTEGAS LIMITED	SAKHALIN 1 PHASE 1 PROJECT -RUSSIA-	AIR COOLERS	2003
ITAS S.P.A. MONZA - ITALY	AGIP GAS BV LIBYAN BRANCH	WESTERN LIBYA GAS PROJECT COASTAL WAFA PLANTS -LIBYA	No. 2 SELF-SUPPORTED STACKS (41/42-320-F-001)	2003
LINDE IMPIANTI ITALIA	JGC FOR AGIP GAS LYBIA	WAFA DESERT PLANT -LYBIA	REGENERATION GAS HEATER (11-310-FA- 001 12-310-FA -001	2003
LINDE IMPIANTI ITALIA	TECNIMONT/SOFRE-GAZ FOR AGIP GAS LYBIA	WAFA DESERT PLANT -LYBIA	STABILIZER REBOILER HEATER (41-320-FA- 002 / 42-320-FA -002)	2003
LINDE IMPIANTI ITALIA	SNAMPROGETTI TECHNIP COFLEXIP	OMAN INDIA FERTILIZER PROJECT -INDIA	STARTUP HEATERS (12-F-501 22-F-501)	2003
LINDE IMPIANTI ITALIA	TECHNIP FOR TOTAL FINA ELF	CLEAN GASOLINE PROJECT PRIME G + ANTWERP -BELGIUM-	STARTUP HEATERS (12-F-501 22-F-501)	2003
OLMI S.p.A - ITALY	TECHINP COMPLEX for SAUDI ARAMCO	BERRI GAS ARABIA SAUDITA	STEAM CONDENSATE CONDENSER	2003
OLMI S.p.A - ITALY	LINDE /STATOIL	KOLLSNES NORVEGIA	REGENERATION GAS COOLER	2003
OLMI S.p.A - ITALY	BASF	LUDWIGSHAFEN-GERMANY	AIR COOLER	2003
TECHNIP K.T.I.	SAUDI ARAMCO	QATIF FACILITIES AT BERRI GAS PLANT	AIR PRE-HEATHER FURNACES ITEM 475-F-0301/475-F-0401& 475-F-0501	2003
TECHNIP K.T.I.	NUOVO PIGNONE AGIP GAS BV LIBYAN BRANCH -LIBYA-	MELLITAH -WHRU GAS COMPRESSION STATION -LIBYA	CONVECTION SECTIONS FOR WHRSG H-620-HW001 / G-620-HW001	2003
FBM-HUNDSON ITALIANA S.p.A.	AMEC - SNEPCO	NIGERIA	STEELWORK AIR COOLER	2002
FBM-HUNDSON ITALIANA S.p.A.	CMS & JOINT VENTURE	RAS LAFFAN -QATAR	STEELWORK AIR COOLER	2002
FBM-HUNDSON ITALIANA S.p.A.	JGC CORPORATION CHINESE PETROLEUM CORPORATION	TAOYUAN, TAIWAN, -REPUBLIC OF CHINA-	STEELWORK AIR COOLER	2002
FBM-HUNDSON ITALIANA S.p.A.	KJT FOR SEGAS -EGYPT	EGYPT LNG PROJECT DAMIETTA -EGYPT	STEELWORK AIR COOLER	2002
HAMON D'HONDT S.A.	CEHELLENIC PETROLEUM SA-GRE	ASPROPYRGOS INDUSTRIAL COMPLEX DIVISION-GREECE	M-4911 M-4901 M-4915 M-4902 -AIR COOLERS	2002
HAMON D'HONDT S.A.	SHEEL C - SAR PROJECT MOERDIJK	SHELL NEDERLANDS CHEMIE B.V.- MOERDIJK - THE NETHERLANDS	STEELWORK AIR COOLER	2002
KIRCHNER ITALIA -ITALY-	TECHINT S.A.C.I / OCP	AMAZONAS PS - 1 / CAYAGAMA PS-2 / SARDINAS PS-3 / PARAMO PS-4	COLD AIR DUCT & DAMPER H- 0101A/B/C/D/E/ + H-0201 + H-0301A/B/C/ COLD AIR DUCT & DAMPER H-0401	2002
KIRCHNER ITALIA -ITALY-	SINOPEC ENGINEERING INCORPORATION / NIOC TEHRAN EXPANSION IRAN	TEHERAN REFINERY -IRAN HEATER	HEATERS: TH-102 / TH-152 / 2H-103 / H-103	2002
KVAERNER HEURTEY ITALIANA MILAN -ITALY-	SNAMPROGETTI	DUKHAN FIELD GAS LIFT PROJECT N. 1504 -QATAR -QUATAR	HEATERS 14F 5218 & 24F 5218	2002
KVAERNER HEURTEY ITALIANA MILAN -ITALY-	BECHTEL INTEC CONSORTIUM -EGYPT-	SCARAB SAFFRON DEVELOPMENT PROJECT -EGYPT-	HEATERS 220 - F - 3085 A 220 - F - 3085 B	2002

Reference List

CLIENT:	CUSTOMER:	LOCATION:	ITEM DESCRIPTION:	YEAR
LINDE IMPIANTI ITALIA	PIDEC -IRAN-	THIRD AROMATIC PLANT -IRAN-	HEATERS (ONLY STRUCTURES) H - 1001, H - 3001, H - 3002, H - 4005, H - 7001	2002
OLMI S.p.A - ITALY	ENI SPA - DIV. AGIP	CENTRO OLIO VAL D'AGRI -ITALY	AIR COOLER FOR OIL SERVICE	2002
TECHNIP K.T.I.	TOTAL FINA ELF -RUSSIA-	KHARYAGA PHASE 2 PROJECT -RUSSIA-	HEATERS H - 4402 & H - 4403	2002
TECHNIP K.T.I.	NUOVO PIGNONE AGIP GAS BV LIBYAN BRANCH	WESTERN LIBYA GAS PROJECT WAFI PLANTSDESERT LYBIA	10-410-HW-001 A/B/C INTER-MEDIATE TUBESHEET	2002
VERGAENGINEERING S.p.A.	SIIRTEC NIGI SPA -ITALY-	GPP KRASNODARSKAJA COMPRESSOR STATION RUSSIA	HEATERS HF - 1 A & HF - 1 B	2002
VERGAENGINEERING S.p.A.	ASPROFOS S.A. -GREECE-	ASPROPYRGOS HAR MODERNIZATION PROJECT -GREECE-	HEATER L - 4901	2002
FBM-HUNDSON ITALIANA S.p.A.	SNAMPROGETTI	DUKHAN FIELD -QATAR-	STEELWORK AIR COOLED HEAT EXCHANGERS	2001
HAMON D'HONDT S.A.	NIOC / POGC - IRAN	SOUTH PARS GAS FIELD DEVELOPEMENT PROJECT - IRAN	STEELWORK AIR COOLER	2001
HAMON D'HONDT S.A.	BHP PETROLEUM PTY. LTD. -ALGERIA	OHANET ALGERIA	STEELWORK AIR COOLER	2001
LINDE IMPIANTI ITALIA	TOYO ENG./ PETROBRAS	NGL RECOVERY (U-206, U-207) -BRASIL	HEATERS F-20601, 20701 F-20602, 20702	2001
OLMI S.p.A - ITALY	WOOD - STORK VOF for NAME	DUTCH SECTOR NORTH SEA	DISCHARGE GAS COOLER INTERSTAGE GAS COOLER LUBE OIL COOLER	2001
OLMI S.p.A - ITALY	SNAMPROGETTI PER ECOLOMBARDIA 4	NUOVO INCENERITORE DI FILAGO (BG)	STEAM CONDENSER	2001
OLMI S.p.A - ITALY	BAZAN OIL REFINERIES LTD	DEEP GAS OIL H.D.S. PLANT	STEELWORK AIR COOLED HEAT EXCHANGERS	2001
OLMI S.p.A - ITALY	HELLENIC PETROLEUM SA - GREECE	VPS UNIT REVAMP TESSANOLIKI INDUSTRIAL COMPLEX-GREECE	E-215 AIR COOLERS	2001
VERGAENGINEERING S.p.A.	ENPPI	SCARAB SAFFRON DEVELOPMENT PROJECT -EGYPT	HEATERS: 240 - F - 6640 / 240 - F - 6650	2001
FBM-HUNDSON ITALIANA S.p.A.	JGC CORPORATION LTD FOR SAUDI ARAMCO -SAUDI ARABIA	HAWIYAH GAS PROJECT -SAUDI ARABIA-	AIR COOLED EXCHANGERS	2000
KVAERNER HEURTEY ITALIANA MILAN -ITALY-	MOTOR OIL (HELLAS) - CORINTH REFINERIES -GREECE-	POWER PLANT EXPANSION PROJECT AGHII THEODORI -CORINTH	STACK & FLUE GAS DUCT SYSTEM WHB -7002	2000
KVAERNER HEURTEY ITALIANA MILAN -ITALY-	CONDEA AUGUSTA -ITALY-	CONDEA AUGUSTA -ITALY-	HOT AIR DUCT DAMPERS HEATERS F-7002 F-5003 F-5004	2000
KVAERNER HEURTEY ITALIANA MILAN -ITALY-	SNAM PROGETTI SUD	API - FALCONARA REFINERY	HOT AIR DUCT DAMPERS HEATERS F-7002 F-5003 F-5004	2000
NUOVO PIGNONE S.p.A VIBO VALENTIA -ITALY-	BECHTEL SNAM PROGETTI JOINT VENTURE -KAZAKHSTAN-	KARACHAGANAK -KAZAKHSTAN	SERVICE WALKWAYS	2000
NUOVO PIGNONE S.p.A. FLORENCE -ITALY	BECHTEL - SNAM PROGETTI JOINT VENTURE -KAZAKHSTAN-	KARACHAGANAK DEVELOPMENT PROJECT PHASE II -KAZAKHSTAN-	PIPING MAIN SUPPORTS- EXTENSION PIPE RACK- SECONDARY PIPE RACK- CABLE TRAY SUPPORTS	2000

Reference List

CLIENT:	CUSTOMER:	LOCATION:	ITEM DESCRIPTION:	YEAR
OLMI S.p.A - ITALY	MOTOR OIL (HELLAS)-CORINTH REFINERIES -GREECE	REFINERY UPGRADING PROJECT AGHII THEODORI-CORINTH	AIR COOLER	2000
VERGAENGINEERING S.p.A.	NATIONAL PETRO-CHEMICAL COMPANY COSTAIN	NGL 1200 & 1300 POLISHING UNITS -IRAN-	REGENERATION GAS HEATERS H-12401-1 & H-13401-1	2000
VERGAENGINEERING S.p.A.	BECHTEL - SNAM PROGETTI JOINT VENTURE	KARACHAGANAK DEVELOPMENT PROJECT -KAZAKHSTAN-	HOT OIL HEATERS 5-340-FA-01	2000
NUOVO PIGNONE S.p.A. FLORENCE -ITALY	BECHTEL - SNAM PROGETTI JOINT VENTURE -KAZAKHSTAN	KARACHAGANAK FIELD DEVELOPMENT -KAZAKHSTAN	PIPE RACK	1999
OLMI S.p.A - ITALY	MOTOR OIL (HELLAS)-CORINTH REFINERIES-GREECE	REFINERY UPGRADING PROJECT AGHII THEODORI-CORINTH	AIR COOLER	1999
OLMI S.p.A - ITALY	PETROCHEMIA PLOCK -POLAND	ISOMERIZATION PROJECT -POLAND	STEELWORK DEBUTANIZER OVHD CONDENSER FEED COOLER	1999
VERGAENGINEERING S.p.A.	BECHTEL - SNAM PROGETTI JOINT VENTURE	KARACHAGANAK DEVELOPMENT -KAZAKHSTAN	HOT OIL HEATERS: 2-411-FA-01A/01B/01C	1999
VERGAENGINEERING S.p.A.	TECHNIP - ITALY PETROCHEMIA PLOCK S.A.	ISOMERIZATION PLANT PLOCK -POLAND	REACTOR CHARGE HEATER 21-H-01	1999
HEURTEY PETROCHEM ITALIANA	SNAM PROGETTI-FOSTER WHEELER - ENERGY - JOINT VENTURE MILAN	ISAB-ENERGY-IG.CC-PROJECT T.PRIOLO (SR)	HOT OIL HEATER 3010-F101	1998
HEURTEY PETROCHEM ITALIANA	ENPPI CORC. MOSTOROD	LIGHT-ISOMERIZATION NAPHTHA -EGYPT	CHARGE-HEATERS 29-H-1/2	1998
HEURTEY PETROCHEM ITALIANA	ENPPI CORC. MOSTOROD	LIGHT-ISOMERIZATION NAPHTHA -EGYPT	CHARGE-HEATERS 29-H-1/2	1998
NUOVO PIGNONE S.p.A. FLORENCE -ITALY	TECHNIP S.p.A. -ROME	CONDENSATE- PROCESSING-PLANT-DUBAI -UNITED ARAB EMIRATES	STEELWORK AIR COOLER	1998
NUOVO PIGNONE S.p.A. FLORENCE -ITALY	SHELL	ODIDI AGS-PROJECT.	STEELWORK AIR COOLER	1998
NUOVO PIGNONE S.p.A. FLORENCE -ITALY	KTI-ROME	MIDOR-REFINERY ALEXANDRIA -EGYPT	STEELWORK AIR COOLER	1998
OLMI S.p.A - ITALY	C.T.C.I. CORPORATION	RENWU-REFUSE-RESOURCE RECOVERY-PLANT-TAIWAN	24 AIR COOLED CONDENSER	1998
VERGAENGINEERING S.p.A.	NASR - PETROLEUM COMPANY	VACUM-ATMOSPHERIC FUEL-OIL-HEATERS-SUEZ- -EGYPT	FIRED-HEATERS F1-2-3	1998
VERGAENGINEERING S.p.A.	ASPROFOS. - GREECE	UNIT.4.600 TIP. HELLENIC ASPROPYRGOS REFINERY	RECYCLE HYDROGEN-HEATER	1998



OMV srl | Officine Metalmeccaniche Vibonesi

Zona Industriale **Porto Salvo**
89900 Vibo Valentia (VV) ITALY



+39 0963 56.10.15



info@omvmetal.it



www.omvmetal.it

